



3-Port Seat Valves with Male Thread, PN 16

VXG44...

- Bronze CC491K (Rg5) valve body
- DN 15...DN 40
- k_{vs} 0.25...25 m³/h
- Flat sealing connections with external thread G...B to ISO 228/1
- Sets of ALG...3 screwed fittings with threaded connection available from Siemens
- Manual adjustment by means of mounted knob
- Can be equipped with SQS... actuators

Use

- In small or medium-sized heating, ventilating and air conditioning plants as a control valve for mixing and diverting functions.
- For closed circuits only.

Media

Cooling water Chilled water Low temperature hot water Water with anti-freeze	1...120 °C
---	------------

Type summary

Type reference	DN	k_{vs} [m ³ /h]	S_v
VXG44.15-0.25	15	0.25	> 50
VXG44.15-0.4		0.4	
VXG44.15-0.63		0.63	
VXG44.15-1		1	> 100
VXG44.15-1.6		1.6	
VXG44.15-2.5		2.5	
VXG44.15-4		4	
VXG44.20-6.3	20	6.3	
VXG44.25-10	25	10	
VXG44.32-16	32	16	
VXG44.40-25	40	25	

DN = Nominal size

k_{vs} = Nominal flow rate of cold water (5...30 °C) through the fully open valve (H_{100}) by a differential pressure of 100 kPa (1 bar)

S_v = Rangeability k_{vs} / k_{vr}

k_{vr} = Smallest k_v value, at which the flow characteristic tolerances can still be maintained, by a differential pressure of 100 kPa (1 bar)

Accessories

Type reference	Description
ALG...3	Set of 3 screwed fittings for 3-port valves, consisting of <ul style="list-style-type: none"> - 3 union nut - 3 discs and - 3 flat seals

Order

When ordering please give quantity, product name and type reference.

Example: 3 valves VXG44.25-10
3 sets of screwed fittings ALG253

Delivery

Valves, actuators and accessories are packed and supplied separately.

Equipment combinations

Valves	Actuators SQS...		Fitting sets
	Δp_{max} mixing [kPa]	Δp_{max} diverting ¹⁾ [kPa]	Type reference
VXG44.15-0.25	400	100	ALG153
VXG44.15-0.4			
VXG44.15-0.63			
VXG44.15-1			
VXG44.15-1.6			
VXG44.15-2.5			
VXG44.15-4			
VXG44.20-6.3			ALG203
VXG44.25-10		75	ALG253
VXG44.32-16	250	50	ALG323
VXG44.40-25	125	35	ALG403

¹⁾ If noise is permitted, the same values apply as for mixing

Δp_{max} = Maximum permissible differential pressure across valve's control path, valid for the entire actuating range of the motorized valve

Actuator overview

Type reference	Operating voltage	Positioning signal		Positioning time	Spring return	Spring return time
SQS35.00	AC 230 V	3 position		150 s	no	—
SQS35.03				35 s		
SQS35.50				150 s	yes	8 s
SQS35.53				35 s		
SQS65.5	AC 24 V	DC 0...10 V	0...1000 Ω	35 s	yes	8 s
SQS65		DC 2...10 V				
SQS65.2		3 position		150 s	no	—
SQS85.00				35 s		
SQS85.03				35 s		

Data sheet actuators SQS...: N4573

Technical design / mechanical design

Valve cross section

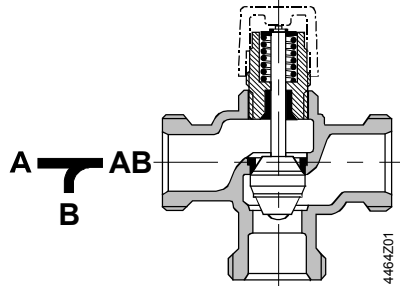

- Guided parabolic plug which is attached to the valve stem.
- The seat is fitted in the through-port and attached directly to the valve body in the bypass.
- From DN25, the seat in the through-port is attached directly to the valve body and fitted to the ring in the bypass.

Sizing

Flow diagram

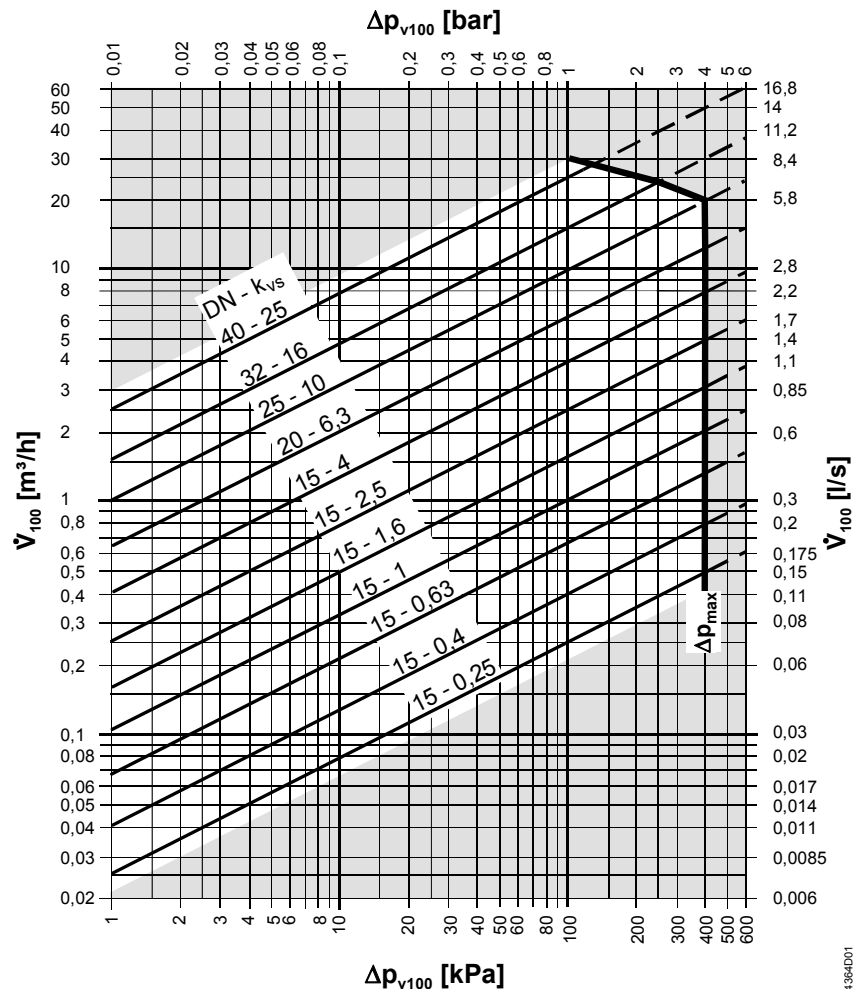

- Δp_{\max} = Maximum permissible differential pressure across the valve's control path, valid for the entire actuating range of the motorised valve
- Δp_{V100} = Differential pressure across the fully open valve and the valve's control path by a volume flow V_{100}
- \dot{V}_{100} = Volume flow through the fully open valve (H_{100})
- 100 kPa = 1 bar \approx 10 mWS
- 1 m³/h = 0.278 l/s water at 20 °C

Valve flow characteristic

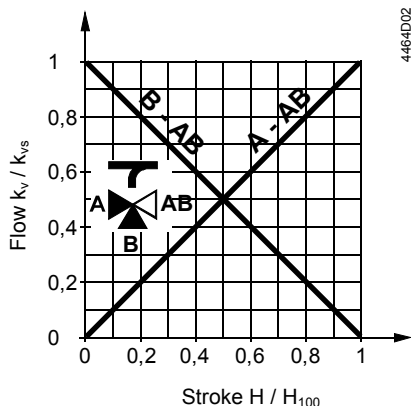

Valve flow characteristic:

Through-port: linear as per VDI /VDE2173
 Bypass: linear as per VDI /VDE2173

Mixing:

Flow from port A and port B to port AB

Diverting:

Flow from port AB to port A and port B

- Port A = variable flow
- Port B = Bypass (variable flow)
- Port AB = constant flow

Use the three-port valve primarily as a mixing valve.

Notes

Engineering

Always use a strainer upstream of the valve to increase the valve's functional safety.

Mounting

Both valve and actuator can easily be assembled at the mounting location. Neither special tools nor adjustments are required.
 The valve is supplied with Mounting Instructions 4 319 9564 0.

Orientation

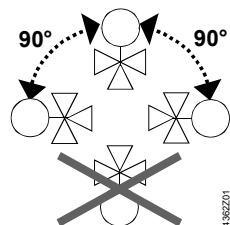

Direction of flow

When mounting, pay attention to the valve's flow direction symbol:

- Mixing from A / B to AB
- Diverting from AB to A / B

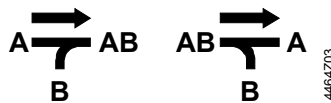

Commissioning



Commission the valve only if the actuator has been mounted correctly.

- Valve stem retracts: Through-port A – AB opens, Bypass closes
- Valve stem extends: Through-port A – AB closes, Bypass opens

Maintenance

VXG44... valves require no maintenance.

Warning

When doing service work on the valve / actuator:

- Deactivate the pump and turn off the power supply
 - Close the shutoff valves
 - Fully reduce the pressure in the piping system, allow pipes to completely cool down
- If necessary, disconnect the electrical wires.

Before putting the valve into operation again, make certain the actuator is correctly fitted.

Stem sealing gland

The stem sealing gland cannot be exchanged. In the case of leakage, the entire valve must be replaced. Contact your local office or branch.

Disposal

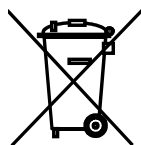

Before disposal the valve must be dismantled and separated into its various constituent materials.

Legislation may demand special handling of certain components, or it may be sensible from a ecological point of view.

Current local legislation must be observed.

Warranty

The technical data given for these applications is valid only in conjunction with the Siemens actuators as detailed under «Equipment combinations».

All terms of the warranty will be invalidated by the use of actuators from other manufacturers.

Technical data

Functional data	PN class	PN 16 to EN 1333
	Permissible operating pressure	1600 kPa (16 bar) to ISO 7268 / EN1333
	Working pressure	to DIN 4747 / DIN 3158 in the range of 1...120 °C
	Flow characteristic	0...100 % linear to VDI / VDE 2173 (through-port and bypass)
	Leakage rate	0...0.02 % of k_{vs} value to DIN EN 1349 (through-port and bypass)
	Permissible media	cooling water, chilled water, low temperature hot water, water with anti-freeze. recommendation: water treatment to VDI 2035
	Medium temperature	1...120 °C
	Rangeability S_v	DN 15: > 50 bzw. > 100 (refer to «Type summary») DN ≥20: >100
	Nominal stroke	5.5 mm
	Industry standards	Pressure Equipment Directive
Pressure Accessories		as per article 1, section 2.1.4
Fluid group 2		without CE-marking as per article 3, section 3 (sound engineering practice)
Materials	Valve body	bronze CC491K (Rg5)
	Seat in the through-port	stainless steel, bronze Rg5 or brass
	Seat in the bypass	bronze Rg5 or brass
	Plug	stainless steel or brass
	Stem	stainless steel
	Sealing gland	brass
Dimensions / Weight	gland materials	EPDM O rings
	Refer to «Dimensions»	
	External thread connections	G...B to ISO 228/1
	Actuator connection	G $\frac{3}{4}$ "

Dimensions

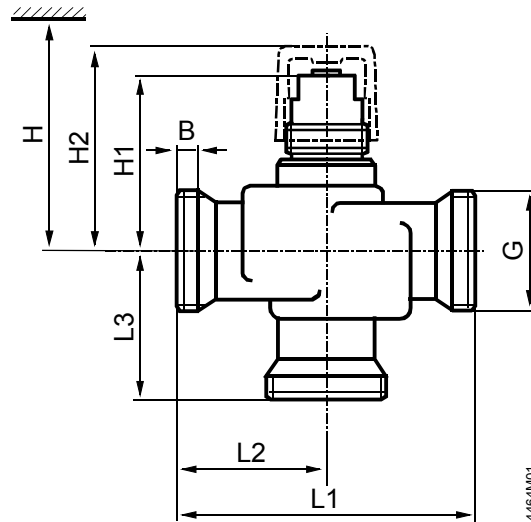

DN = Nominal size

H = Total actuator height plus minimum distance to the wall or the ceiling for mounting, connection, operation, service, etc.

H1 = Dimension from the pipe centre to install the actuator

H2 = Pipe centre to upper edge of manual adjustment button, valve in «closed» position (A – AB)

Type reference	DN	B [mm]	G [Zoll]	L1 [mm]	L2 [mm]	L3 [mm]	H1 [mm]	H2 [mm]	H SQS...	Weight [kg]
VXG44.15-0.25	15	8.5	G1B	100	50	50	53	63	> 364	0.5
VXG44.15-0.4										
VXG44.15-0.63										
VXG44.15-1										
VXG44.15-1.6										
VXG44.15-2.5										
VXG44.15-4	20	9	G1½B	105	52.5	52.5	68	78	> 379	0.85
VXG44.20-6.3										
VXG44.25-10										
VXG44.32-16	32	11	G2B	130	65	65	77.5	87.5	> 389	1.6
VXG44.40-25	40		G2¼B				80.5	90.5	> 392	2.3

Screwed fittings

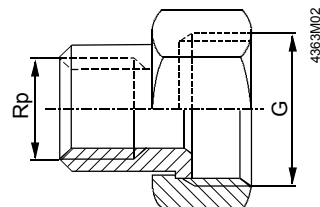

Type reference	for valve type	G [Zoll]	Rp [Zoll]
ALG15...	VXG44.15...	G1	Rp½
ALG20...	VXG44.20	G1¼	Rp¾
ALG25...	VXG44.25	G1½	Rp1
ALG32...	VXG44.32	G2	Rp1¼
ALG40...	VXG44.40	G2¼	Rp1½

- On valve side: cylindrical thread to ISO 228/1
- On pipe side: with cylindrical thread to ISO 7/1